

# BRCS080N02RA

Rev.B May.-2025

## 描述 / Descriptions

TO-220 塑封封装 N 沟道场效应管。

N-CHANNEL MOSFET in a TO-220 Plastic Package.

## 特征 / Features

低电阻,开关速度快。

Ultra Low On-Resistance,fast switching.

## 用途 / Applications

电源开关应用,负载开关,不间断电源。

Power switching application,Load switching,Uninterruptible power supply

## 内部等效电路 / Equivalent Circuit

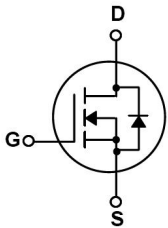

## 引脚排列 / Pinning

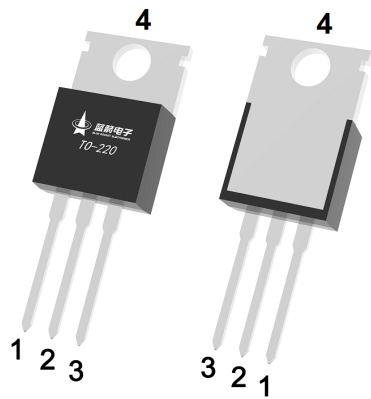

PIN1 : G

PIN 2、4 : D

PIN 3 : S

## 印章代码 / Marking

见印章说明。

See Marking Instructions.

**极限参数 / Absolute Maximum Ratings(Ta=25°C)**

参数 Parameter	符号 Symbol	数值 Rating	单位 Unit
Drain-Source Voltage	V <sub>DSS</sub>	20	V
Drain Current	I <sub>D</sub> (Tc=25°C)	60	A
Pulsed Drain Current	I <sub>DM</sub>	187	A
Gate-Source Voltage	V <sub>GS</sub>	±12	V
Single Pulsed Avalanche Energy(L=0.5mH)	E <sub>AS</sub>	127.6	mJ
Avalanche Current	I <sub>AS</sub>	13.5	A
Total Power Dissipation	P <sub>D</sub> (Tc=25°C)	45	W
Junction and Storage Temperature Range	T <sub>J</sub> , T <sub>STG</sub>	-55 to 150	°C
Thermal Resistance-Junction to Ambient	t ≤ 10s	15	°C/W
	Steady-State	62.5	
Thermal Resistance-Junction to Case	Steady-State	2.8	

**电性能参数 / Electrical Characteristics(Ta=25°C)**

参数 Parameter	符号 Symbol	测试条件 Test Conditions	最小值 Min	典型值 Typ	最大值 Max	单位 Unit
Drain-Source Breakdown Voltage	BV <sub>DSS</sub>	V <sub>GS</sub> =0V I <sub>D</sub> =250μA	20	22		V
Zero Gate Voltage Drain Current	I <sub>DSS</sub>	V <sub>DS</sub> =20V V <sub>GS</sub> =0V			1	μA
Gate-Body Leakage Current Forward	I <sub>GSS</sub>	V <sub>GS</sub> =±12V V <sub>DS</sub> =0V			±100	nA
Gate Threshold Voltage	V <sub>GS(th)</sub>	V <sub>DS</sub> =V <sub>GS</sub> I <sub>D</sub> =250μA	0.5	0.67	1.1	V
Static Drain-Source On-Resistance	R <sub>DS(on)</sub>	V <sub>GS</sub> =10V I <sub>D</sub> =20A		7	8	mΩ
	R <sub>DS(on)</sub>	V <sub>GS</sub> =4.5V I <sub>D</sub> =10A		8	11	
	R <sub>DS(on)</sub>	V <sub>GS</sub> =2.5V I <sub>D</sub> =5A		10	16	
Forward On Voltage	V <sub>SD</sub>	V <sub>GS</sub> =0V I <sub>S</sub> =1A		0.74	1.2	V
Gate resistance	R <sub>g</sub>	f=1MHz		1.8		Ω
Input Capacitance	C <sub>iss</sub>	V <sub>DS</sub> =15V V <sub>GS</sub> =0V f=1MHz		1100		pF
Output Capacitance	C <sub>oss</sub>			160		
Reverse Transfer Capacitance	C <sub>rss</sub>			130		
Total Gate Charge	Q <sub>g(4.5V)</sub>	V <sub>DS</sub> =10V I <sub>D</sub> =12.0A V <sub>GS</sub> =4.5V		17.9		nC
Gate-Source Charge	Q <sub>gs</sub>			1.5		
Gate-Drain Charge	Q <sub>gd</sub>			4.7		

**电性能参数 / Electrical Characteristics(Ta=25°C)**

参数 Parameter	符号 Symbol	测试条件 Test Conditions	最小值 Min	典型值 Typ	最大值 Max	单位 Unit
Turn-On Delay Time	$t_{d(on)}$	$V_{GS}=4.5V$ $V_{DS}=10V$ $R_L=1.25\Omega$ $R_{GEN}=3\Omega$		2.9		ns
Turn-On Rise Time	$t_r$			3.1		
Turn-Off Delay Time	$t_{d(off)}$			42		
Turn-Off Fall Time	$t_f$			10		

电参数曲线图 / Electrical Characteristic Curve

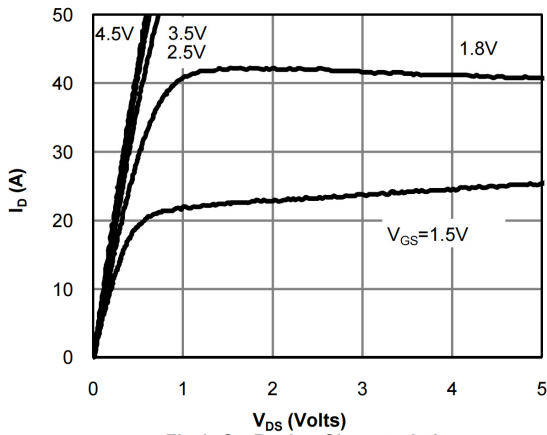

Fig 1: On-Region Characteristics

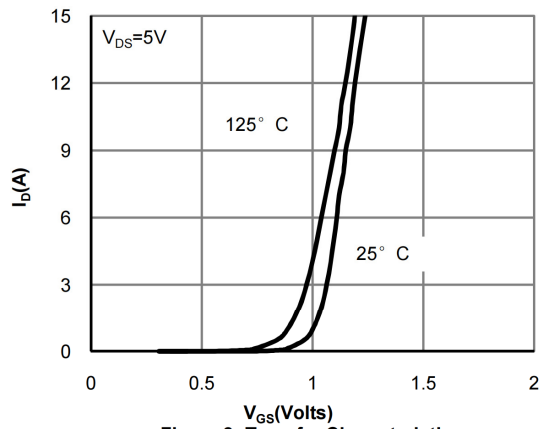

Figure 2: Transfer Characteristics

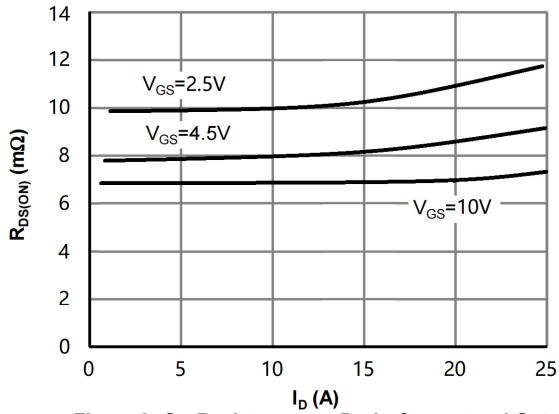

Figure 3: On-Resistance vs. Drain Current and Gate Voltage

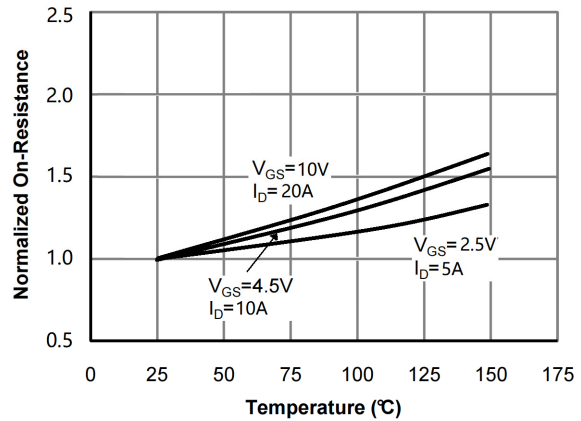

Figure 4: On-Resistance vs. Junction Temperature

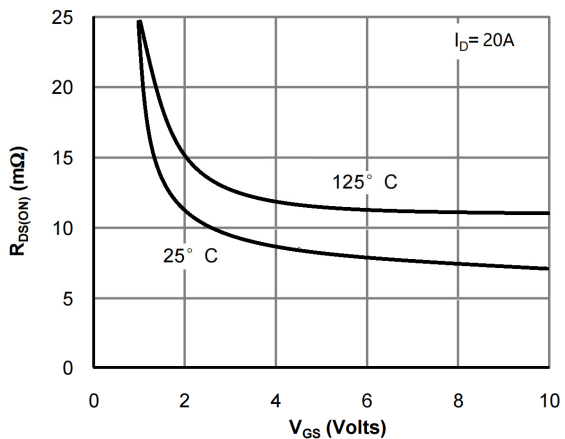

Figure 5: On-Resistance vs. Gate-Source Voltage

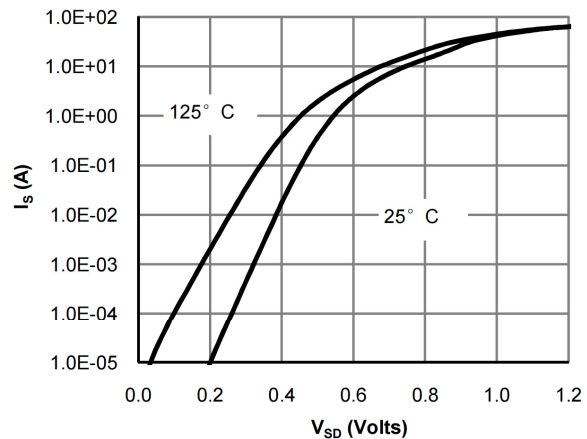

Figure 6: Body-Diode Characteristics

**电参数曲线图 / Electrical Characteristic Curve**

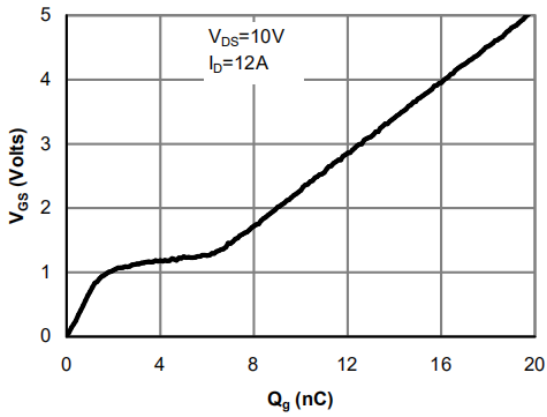

Figure 7: Gate-Charge Characteristics

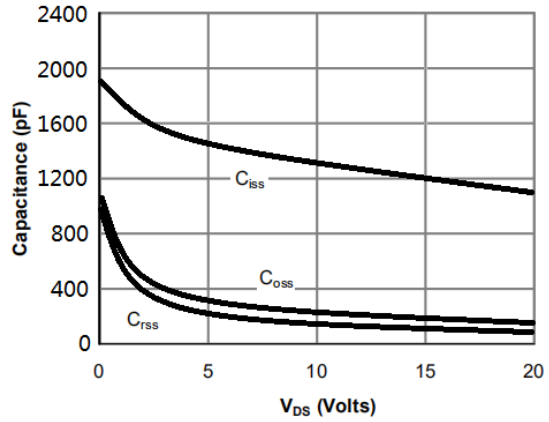

Figure 8: Capacitance Characteristics

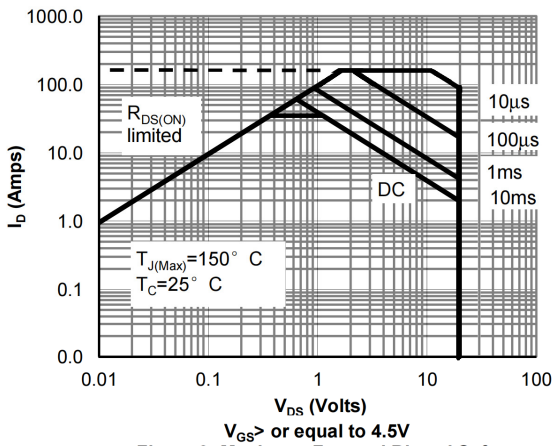

Figure 9: Maximum Forward Biased Safe Operating Area  
 $V_{GS} > \text{or equal to } 4.5V$

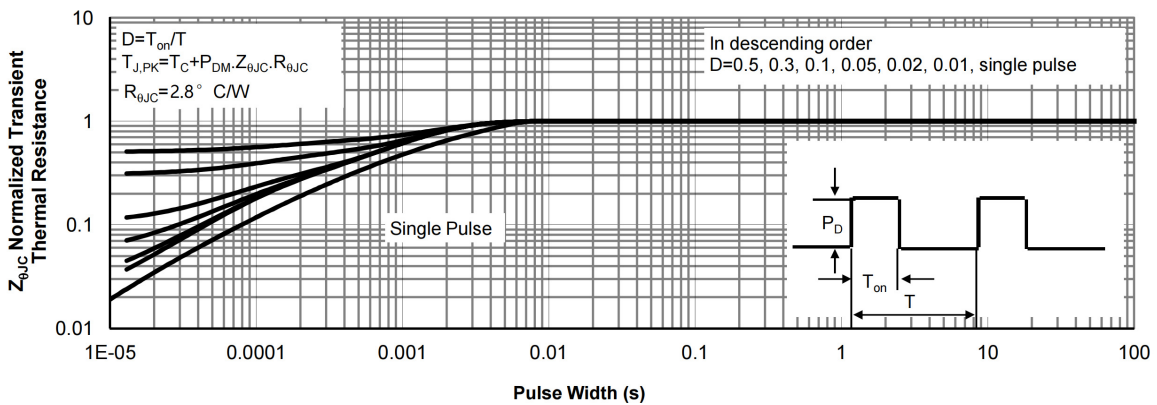
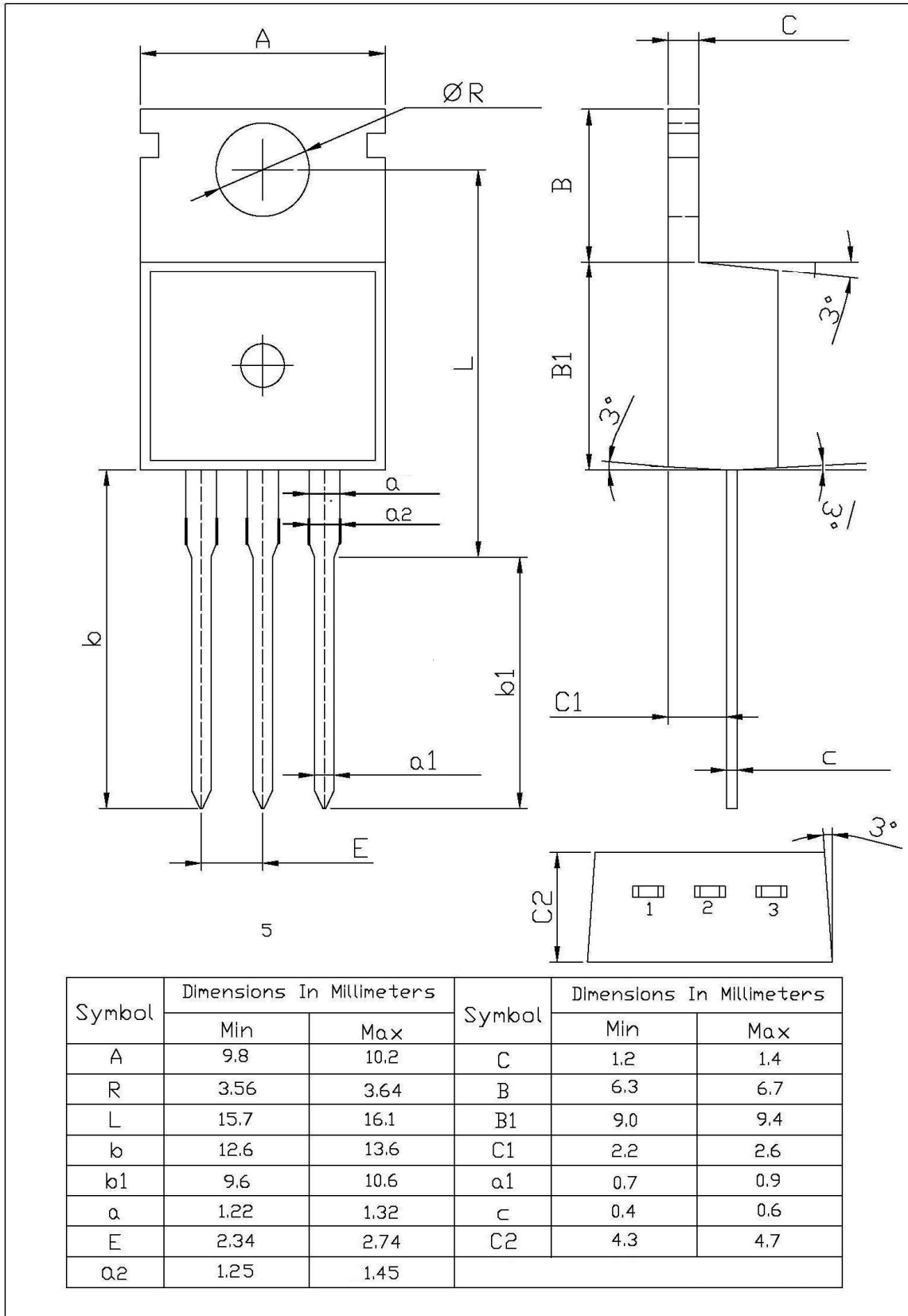

Figure 10: Normalized Maximum Transient Thermal Impedance

外形尺寸图 / Package Dimensions

T□-220

单位: mm



**印章说明 / Marking Instructions**

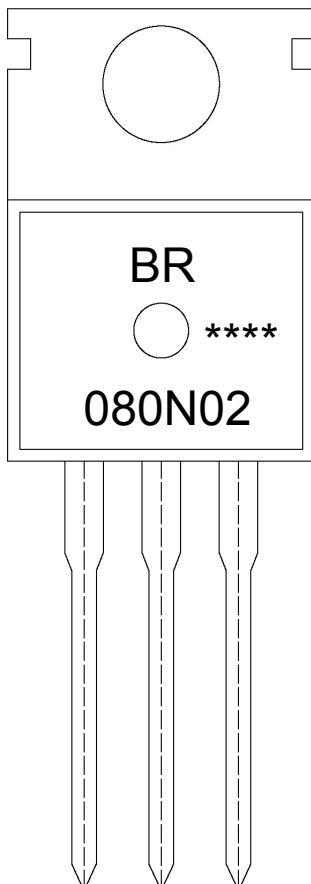

说明：

BR： 为公司代码

080N02： 为型号代码

\*\*\*\*： 为生产批号代码，随生产批号变化

Note:

BR: Company Code

080N02: Product Type Code

\*\*\*\*: Lot No. Code, code change with Lot No.

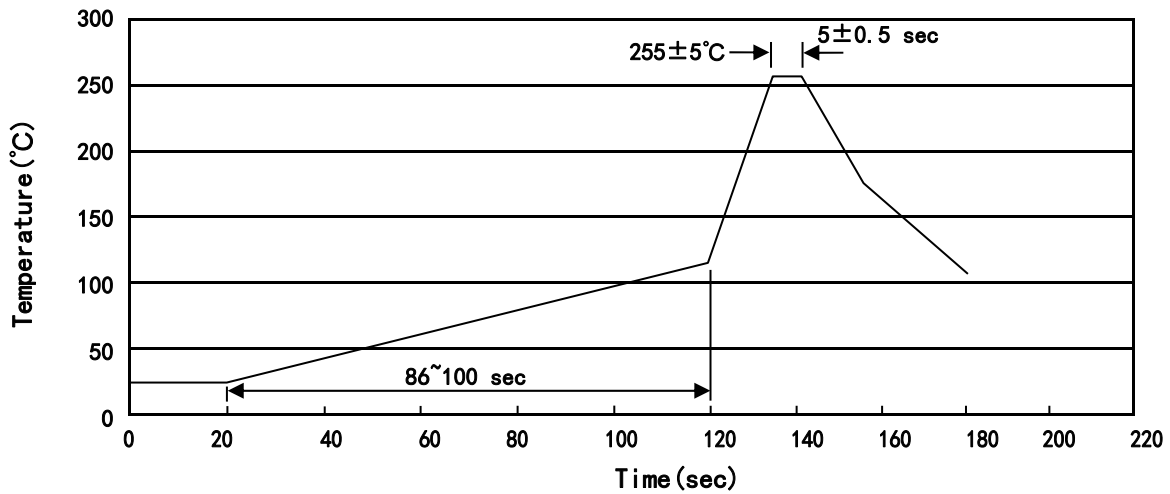
**波峰焊温度曲线图(无铅) / Temperature Profile for Dip Soldering(Pb-Free)**

说明：

- 1、预热温度 25~150°C，时间 60~90sec;
- 2、峰值温度 255±5°C，时间持续为 5±0.5sec;
- 3、焊接制程冷却速度为 2~10°C/sec.

Note:

- 1.Preheating:25~150°C, Time:60~90sec.
- 2.Peak Temp.:255±5°C, Duration:5±0.5sec.
3. Cooling Speed: 2~10°C/sec.

**耐焊接热试验条件 / Resistance to Soldering Heat Test Conditions**

温度：270±5°C

时间：10±1 sec.

Temp.:270±5°C

Time:10±1 sec

**包装规格 / Packaging SPEC.**

散件包装 / BULK

Package Type 封装形式	Units 包装数量					Dimension 包装尺寸 (unit: mm <sup>3</sup> )		
	Units/Bag 只/袋	Bags/Inner Box 袋/盒	Units/Inner Box 只/盒	Inner Boxes/Outer Box 盒/箱	Units/Outer Box 只/箱	Bag 袋	Inner Box 盒	Outer Box 箱
TO-220/F	200	10	2,000	5	10,000	135×190	237×172×102	560×245×195

套管包装 / TUBE

Package Type 封装形式	Units 包装数量					Dimension 包装尺寸 (unit: mm <sup>3</sup> )		
	Units/Tube 只/套管	Tubes/Inner Box 套管/盒	Units/Inner Box 只/盒	Inner Boxes/Outer Box 盒/箱	Units/Outer Box 只/箱	Tube 套管	Inner Box 盒	Outer Box 箱
TO-220/F	50	20	1,000	5	5,000	532×31.4×5.5	555×164×50	575×290×180

**使用说明 / Notices**